

# Secret of the Great Pyramid

The planet number Pi and the the  
Revelation revealed

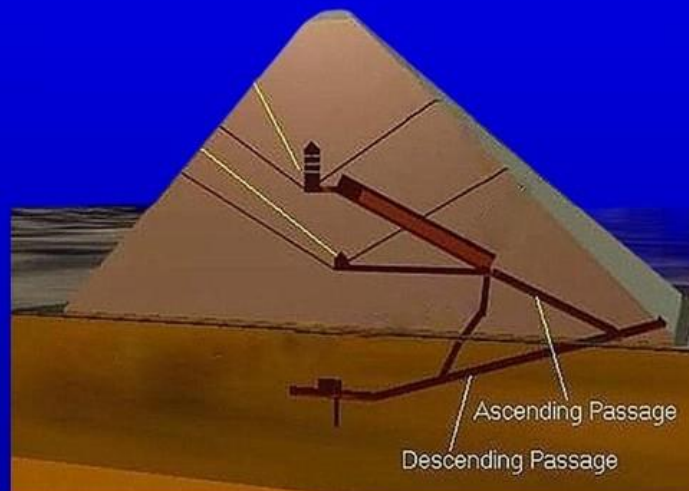

Wim van Es

Secret of the Great Pyramid.  
Wim van Es

© 2023 Wim van Es

[info@wim-vanes.nl](mailto:info@wim-vanes.nl)

CIP - data Koninklijke Bibliotheek, The Hague

ISBN: 978-90-9036990-7

NUR: 921

Keyword: fundamental math.

***© No part of this book may reproduced in any form, be print, photoprint, microfilm or any other means without written permission from the publisher.***

# Secret of the Great Pyramid

The Planet number Pi and the Revelation revealed.

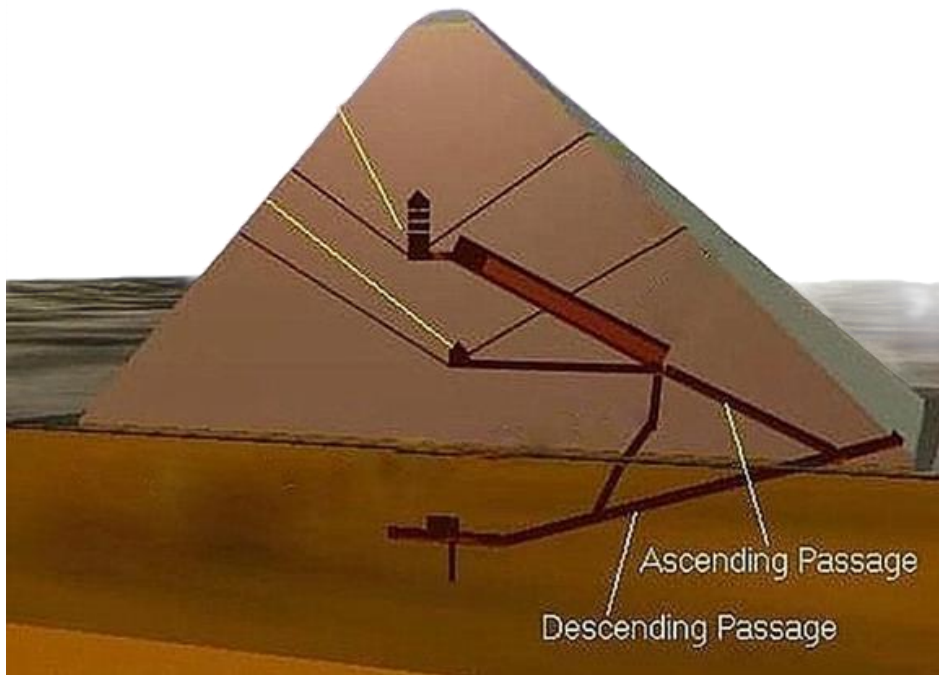

**Wim van Es**

# Preface

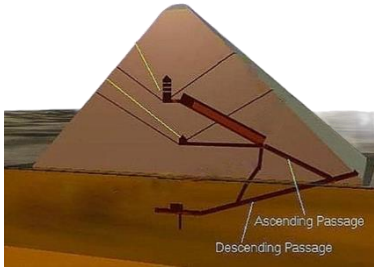

This booklet, this publication, is different from all my previous geometric booklets. My previous publications focus on demonstrable geometric knowledge and facts present in the Great Pyramid.

This booklet has another purpose. It contains a geometric (mathematically cryptic) 'pyramid secret' that is unknown and is only for the 'initiates' to reveal.

It contains a demonstrable geometric, mathematical, relationship between science and religion. It shows that science has not discovered the greatest mathematical "proof" (secret) in the Bible (planet number PI and the hidden cryptic numbers). In this booklet I am going to describe demonstrable "evidence" (relationship) between the Great Pyramid and the numbers in Genesis and Revelation.

The secret of the Great Pyramid can be found in the corridors.



Wim van Es

January 2023

## Introduction

Man over the centuries has distorted everything that has been transmitted orally. And that is logical, that is a logical psychic process in the always personal interpretation of information in the human mind.

How does that work?

It starts with listening. Man does not listen to each other (with exceptions). Man thinks he can listen well, but he doesn't know what listening is? The reason is simple. We hear what the other person is saying and interpret his or her words according to what we think the other person means.

What you think you hear and think you understand is therefore always a false statement. Because how do you know if what you think you hear (internal interpretation) is correct with what the other person thinks? Someone expresses an opinion and before he or she has finished talking, the other often has his or her own opinion ready. We do not listen but interpret the information we take in in our own way all day long. So, we always create our own reality, and it can be very different from the reality that someone else has about the same situation. There are no two equals and no two are the same. There is always difference.

Suppose I say, *'many people are bad'*. Then everyone reading this will have their own opinion about it. He will always internally interpret this writing (this saying) in his own way. He can think of war, aggression, crime, theft, fraud, corruption, and so on.

I mean; that my supervisors have not treated me well at work, and that is why I say, '*many people are bad*', from an emotion at the time.

So, everything you interpret yourself is always different from what the other person means. And that is not listening. Listening is not interpreting and not forming an opinion.

Learning to listen is an art.

Listening means not talking, and repeating the other person's words as much as possible exactly as he or she said them, without incorporating your own words. And man on Earth does not do that. People (with exceptions) cannot communicate well.

Good communication is gaining insight into the subjective perception (experience) of the other person. This way you know what the other person means, and you can then form your own opinion based on what the other person means. You have then listened and asked for the deeper meaning of his or her thoughts (words) and gained insight into what his or her thinking and experience is behind the words he or she utters.

Based on the current Earth communication in 2023, it can be said that man communicates poorly, does not listen, and often puts his own opinion above all else.

Figure 1 shows how it works in people's heads. Every other person's word and all the information we perceive throughout the day are filtered into our head.

There are three main filters: omissions, distortions, and generalizations. Then there are several sub filters.

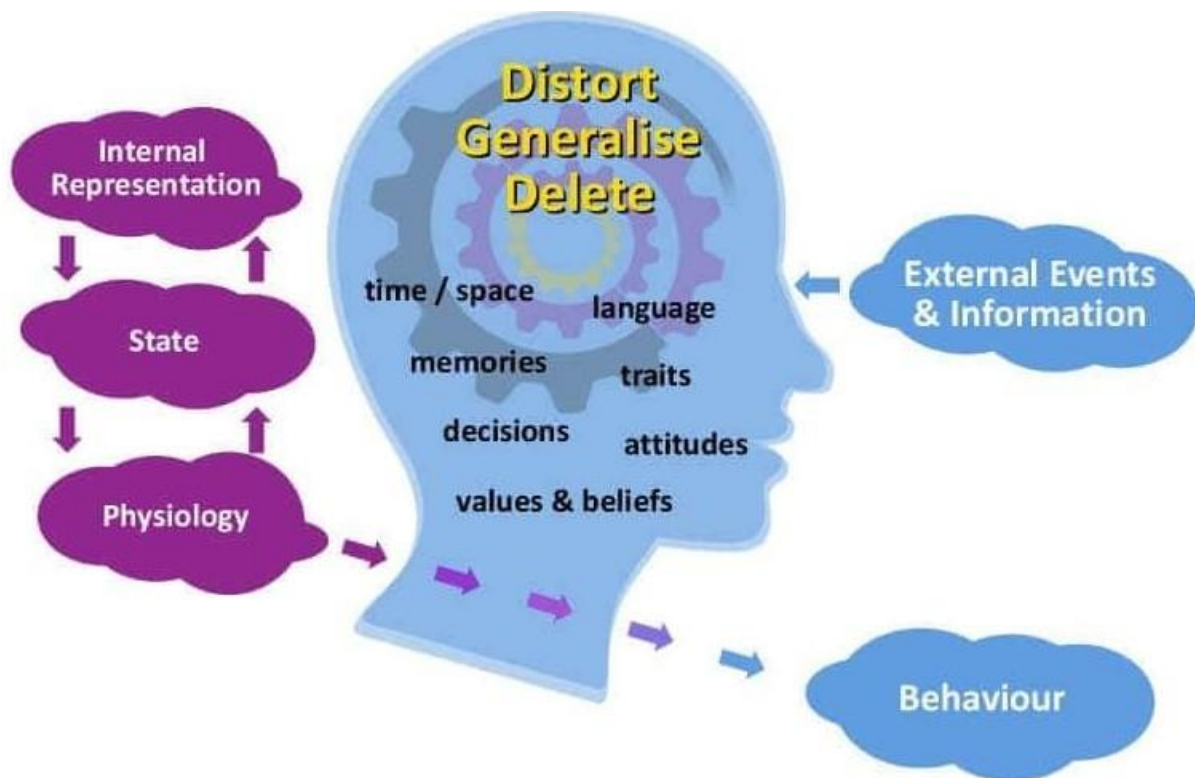

**Communication model**

**Figure 1**

Every person filters the information in his own way. So you can never claim that you completely understand someone else? That is not possible. Each filter system is unique and, like a fingerprint, always personal. Two equals do not exist. There is always difference. So if you as a human being are looking for an equal or like-minded person, then know that you are pursuing an illusion, because this is not possible.

The next step is the internal representation based on the preferred system in your sensory perception.

The next step is your mood when you take in the information. And your physiology matters. Are you limited, are you active, are you lazy, etc. ...

When you finally pronounce your words, after your own personal interpretation, the other person will do the same in their own way. He or she then starts his or her own filter and representation process again and eventually interprets everything in his or her way.

In the end you end up with a jumble of information and words that completely deviate from what is 'really' meant. Because every person creates his own 'reality' and we call this our own personal world model as we personally, and each person for himself, shape the world.



*The effect of our communication is the response we get.*

Gaining insight into the subjective experience of the other person is the only good way of communicating.



Consciousness and its development determine how you look at the world and the environment.

You can divide the development phase of consciousness into 10 steps. The 10 levels of development speak for themselves. I'm going to discuss them.

### Step 1

The childish discovery phase.

- The child observes and explores and discovers the world.

### Step 2

- The child grows up and enters his dream and fantasy world. He is among dragons, demons, gods, elves, fairies, etc.

### Step 3

- Man grows up and comes to the stage where he believes and assumes that 'high scholars' have the truth, without going to investigate and test it himself, whether it is also true what one believes in and what one assumes.

### Step 4

- Man, himself investigates to find out the truth and to realize truth-finding.

### Step 5

- The human being starts to see the connections between subjects, He establishes relationships between what is possible and what is not possible.

## Step 6

- People will become more and more immersed in the subjects and test the (knowledge) subjects for logic (practice) and understanding.

## Step 7

- The scientist is mainly concerned with what is known in science and builds on this knowledge.

## Step 8

- The scientist looks for opportunities for change by looking at things in a different way. The changes are in all cases based on elements that he knows in his consciousness. He cannot take a subject (element) into his thinking with which he has no reference. He uses the knowledge available to generate new ideas.

## Step 9

- The scientist conducts his research based on imaginary thought processes. He's going to study subjects that don't make sense, that don't exist. To then bring them back to an understandable and logical design. His consciousness is focused on the motto "anything goes."

## Step 10.

- This level of development transcends all other levels. The Earth and humans are then only a minuscule part of the big picture. It is thinking 'out of the box'.

The levels of development in 10 steps in figure 2.

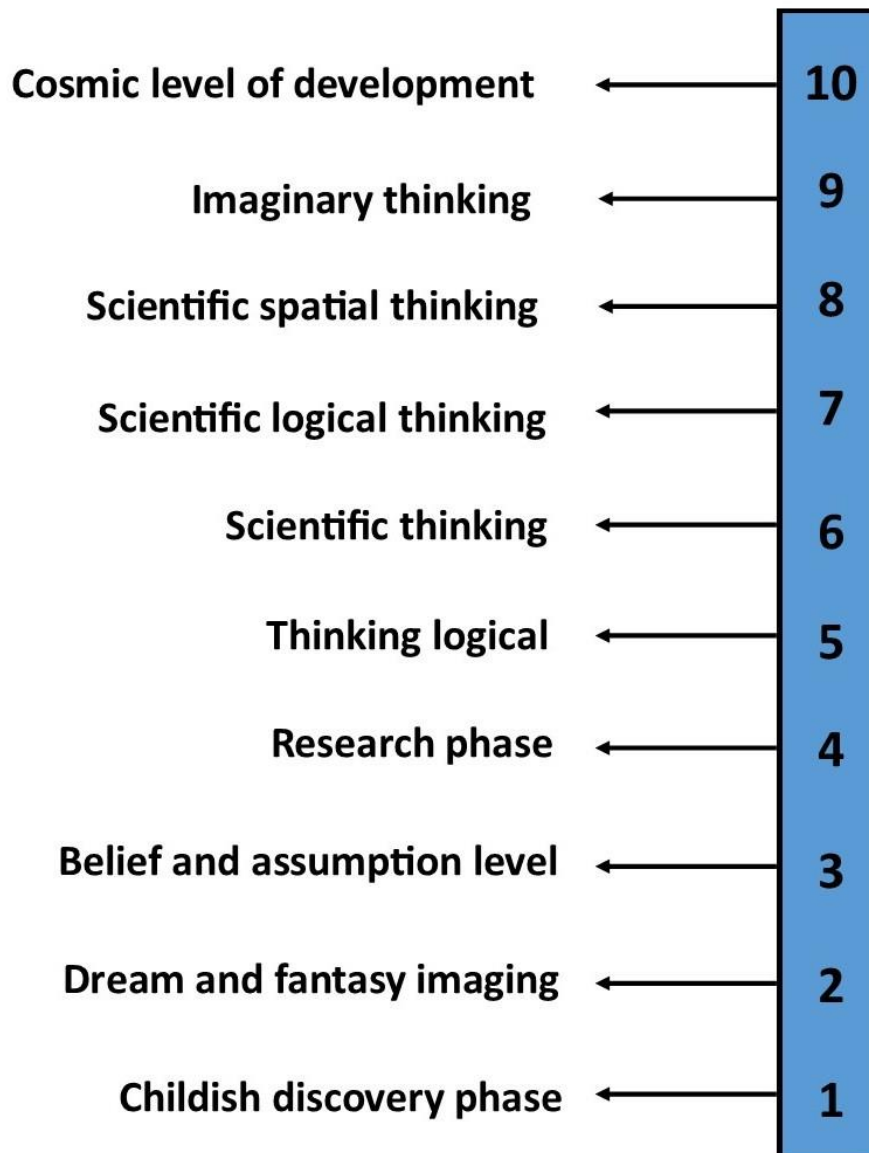

**Figure 2**

At what level of scale do you think you are as a reader?

Now ask yourself the question; how would you, as a scientist at scale 10 level, explain something to a child at scale 2 and 3 level, about how processes in the universe work, or how the Earth's atmosphere came into being?

If you then consider that this child is on scale 2 based on visual language and then also lives in a time (2000 - 4000 years ago) where social superstitions (demons, dragons, gods, angels and wizards) are the order of the day, how are you going to explain this to them? You will be understood if you explain everything on their level (2).

Saint Nicholas riding his horse over the roofs. Wodan driving his chariot through the air when it thunders. Thor striking the clouds with his hammer when lightning strikes. The sun sailing past the Earth with the solar boat. Moses splitting the sea with his staff. Jesus walking on water. Noah sailing his boat (ark) over a mountain 5 kilometers high and gets stuck on its top. And so, I can tell even more fantastic stories that children (humans) at level 2 and 3 find beautiful (2000 - 4000 years ago) and take them for fantastic reality.

We now live 6000 years further in a modern age in 2023. I hope that we as humans now have a different level of development than then. We now know why it thunders and lightning, so Wodan and Thor are gone. We now know that the Earth revolves around the sun. We know that throwing a walking stick into the sea will not change the sea. We know that anything heavier than water will sink. That the sea level worldwide really cannot rise 5 kilometers.

So what level are you at now with your development of consciousness?

You can now ask yourself, were and are all these fun, exciting childish stories, or is there a reality behind them?

If so, is it important to bring this reality to light? And that is the purpose of this booklet. I'm going to show you the scientifically demonstrable reality behind this childish imagery. I do this by linking a few separate stories together and then you can determine for yourself to what extent all this is logical and understandable.

## **Chapter 1**

### **The pyramid timeline.**

I have said before that mathematics and archeology hardly go together. This also applies to pyramidology.

#### **What is Pyramidology?**

Pyramidology is a collective name for pseudoscientific and esoteric interpretations of the construction and origin of the Egyptian pyramids. And that in particular for the Great Pyramid.

#### **What is Pseudoscience?**

Pseudoscience is the name for a system of beliefs, statements, or actions that fail the test of scientific method, but whose adherents claim or suggest that it is science. Presented results of pseudoscience cannot be confirmed. It may involve imitating scientific explanations and explanations, without prior research according to scientific protocols. Many scientists also refer to pyramidology as pyramid mania, as if it were a mental illness that belongs to the category of psychological delusions according to the DSM 5 (psychological diagnosis book).

One of the pyramidologists was Charles Taze Russell, born February 16, 1852, in Pennsylvania and died October 31, 1916 in Texas. Charles Taze Russell was convinced until his death that the measurements in the Great Pyramid of Giza had prophetic significance. See his figure 3.

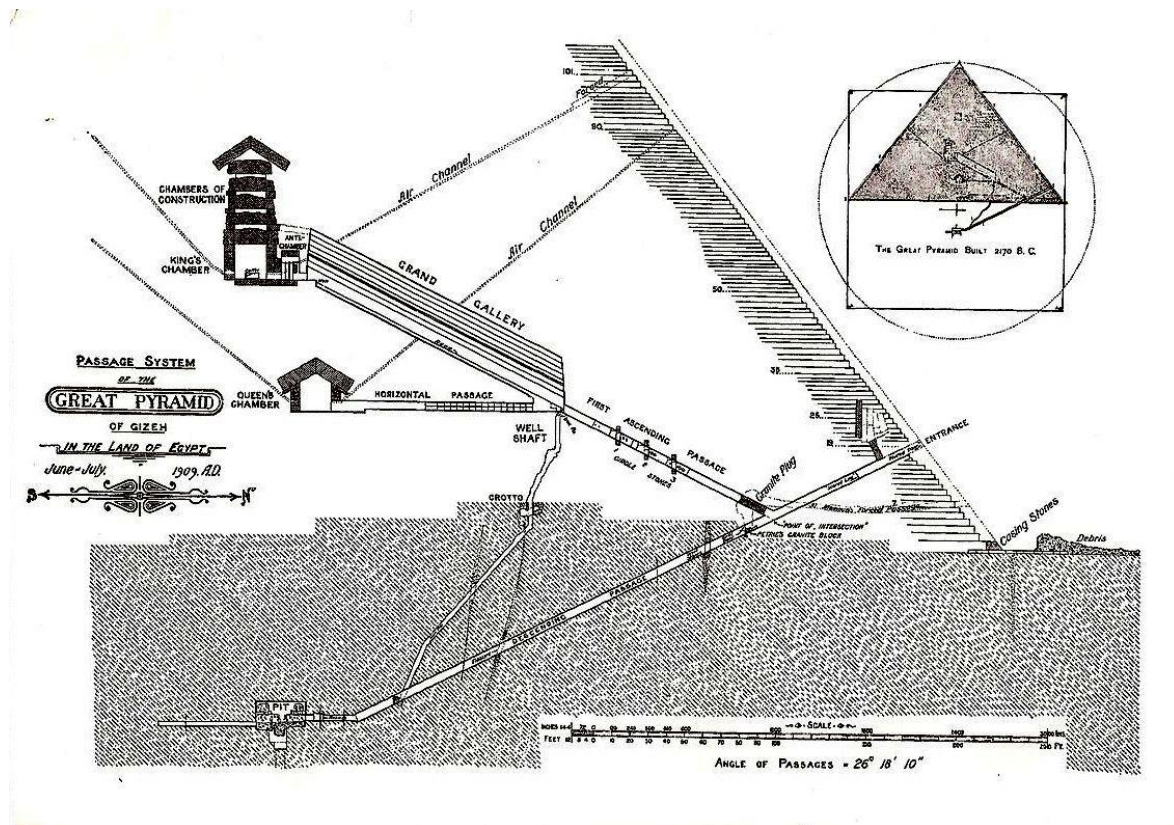

Figure 3

He has never been able to prove this.

Now suppose he had been able to prove it, was it science or still pseudoscience?

Determine it yourself?

Because I'm going to prove it now.

I go back to my previous booklets (publications) regarding the dimensions in the Great Pyramid.

What is now known, considering my previous booklets (publications) on the geometry and mathematics of the Great Pyramid? See my publications: *'mathematics of the golden pyramid'* and *'mathematics of the great pyramid'*.

To begin with, there is the  $\sqrt{1} - \sqrt{2} - \sqrt{3}$  triangle. In a pyramid ratio of 6:6:6, the dimensions are 5.19 cm: 4.24 cm: 3 cm (rounded).

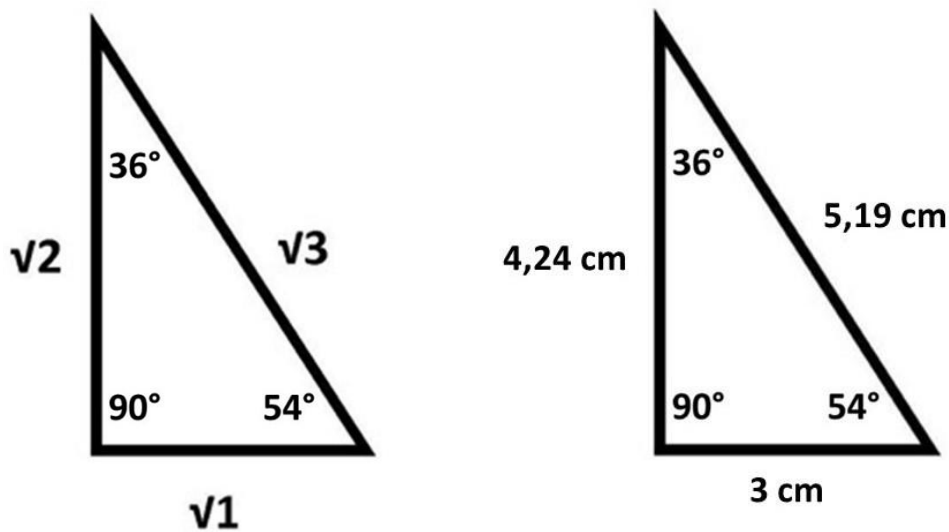

The pyramid number  $\pi = 4.24 + 5.19 = 9.43 : 3 = 3.1433333 \dots$

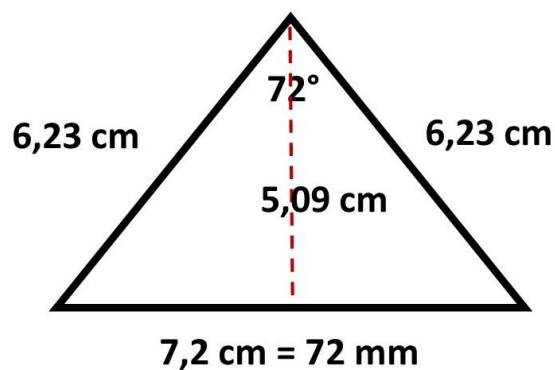

Then there is the pentagram and the resulting  $72^\circ$  triangle.

The pentagram shows two adjacent triangles in the ratio  $\sqrt{1} - \sqrt{2} - \sqrt{3}$ . In this case  $\sqrt{1} = 3.6$  cm,  $\sqrt{2} = 5.09$  cm and  $\sqrt{3} = 6.23$  cm (rounded). The pentagram number  $\text{Pi} = (6.23 \times 2) + (5.09 \times 2) = 22.64 / 7.2 = 3.1444444\dots$

A unique golden spiral based on an equilateral triangle is the icing on the cake, you could say.

Five equilateral triangles from large to small or small to large, with the ratio Phi (1.61) as the center of an equilateral triangle in the ratio 6:6:6 completes the spiral.

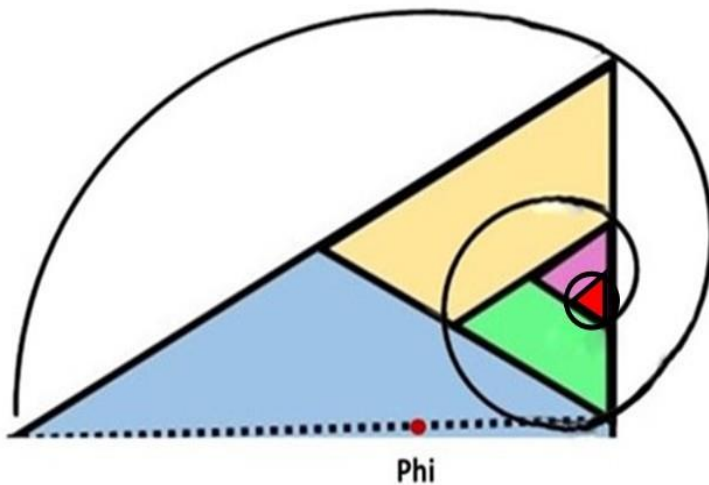

If you draw an equilateral triangle of 12 cm, the number Phi is  $2 \times 1.61 = 3.22$  cm (from right to left) for the right triangle. The five equilateral triangles multiply or diminish by a factor of 2.

Subsequently, the equilateral triangular ratio 6:6:6 has been extensively discussed in the previous geometric (mathematical) publications.

And on the square ratio 6:6:6:6.



It is the 6:6:6 ratio that is essential to make trigonometric calculations.

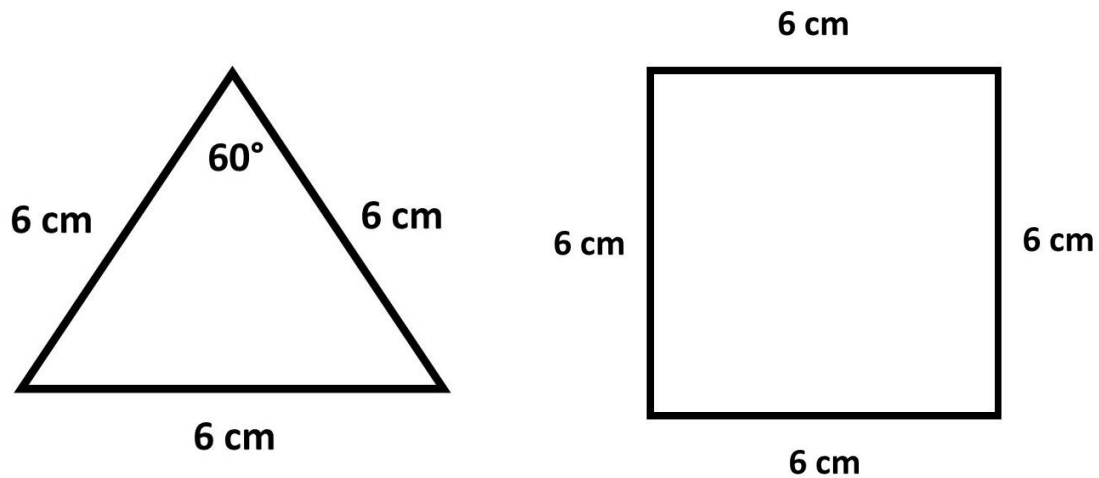

All this is known from my previous publications.

***To confirm the belief of Charles Taze Russell (see figure 3) you need four measures of the above triangles. These are the sizes 7.2 cm, 6 cm, 5.19 cm, and 4.24 cm. And you need the triangular ratio number 666 and the square ratio number 6666. That's all you need. Draw the pyramid figure 4.***

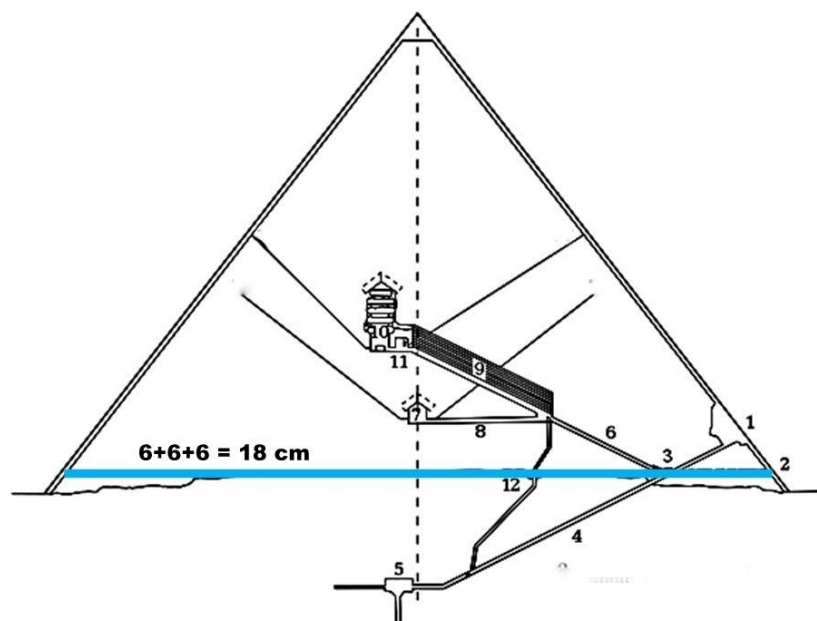

Figure 4

Figure 4 shows what the inner dimensions of the Great Pyramid are and how large the outer dimensions are in the square, if you take the number 666 (6+6+6 in addition) as a starting point.



Figure 4 indicates to draw (design) a base line (ground line) of the pyramid which is 18 cm (color blue) (666). Figure 4 shows the inside of the pyramid (two adjacent triangles in the ratio  $\sqrt{1} - \sqrt{2} - \sqrt{3}$ ).

The height of the pyramid drawn in figure 4 is then easy to calculate:  $9 \times \sqrt{2}$ . If we multiply this by 18, you get the outer size in meters = 229.1 m.

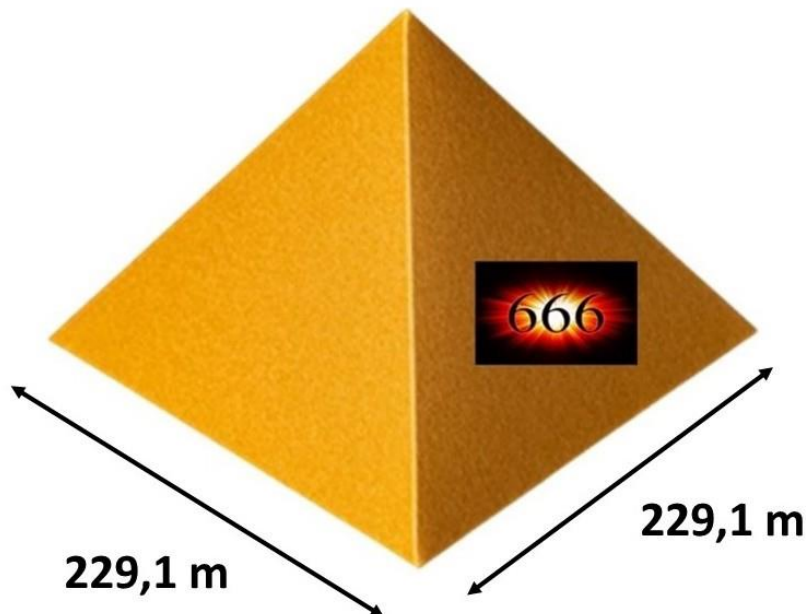

I am now going to transform Charles Taze Russell's pseudoscience (see figure 3) into science.

I do this based on the four sizes 7.2 cm, 6 cm, 5.19 cm, and 4.24 cm in a pyramid ratio with a baseline of 18 cm.

The equilateral triangle is directed upwards, and the number 666 is the starting point.

The square is the foundation of the pyramid and directed downwards and the number 6666 is the starting point.

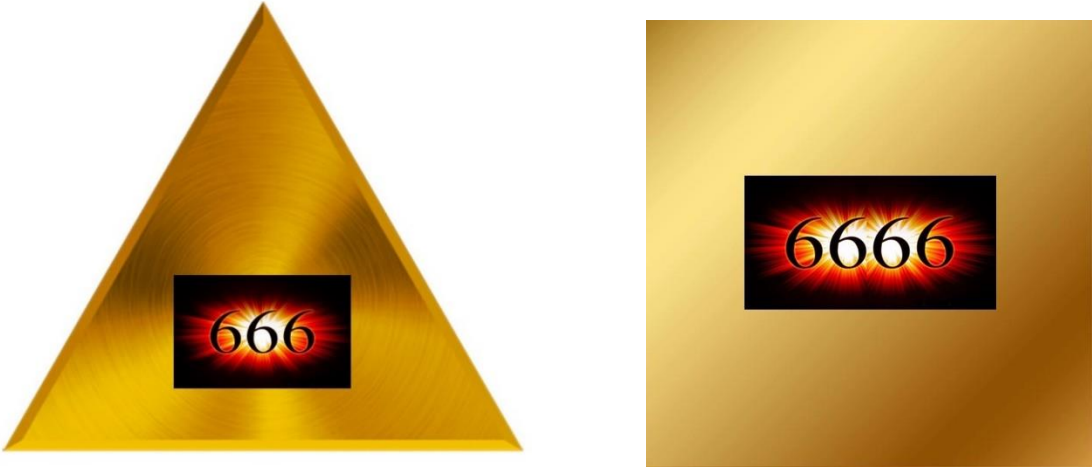

I'm going to start with the timeline now. The time reckoning of the Great Pyramid is located in the corridor system, see figure 5.

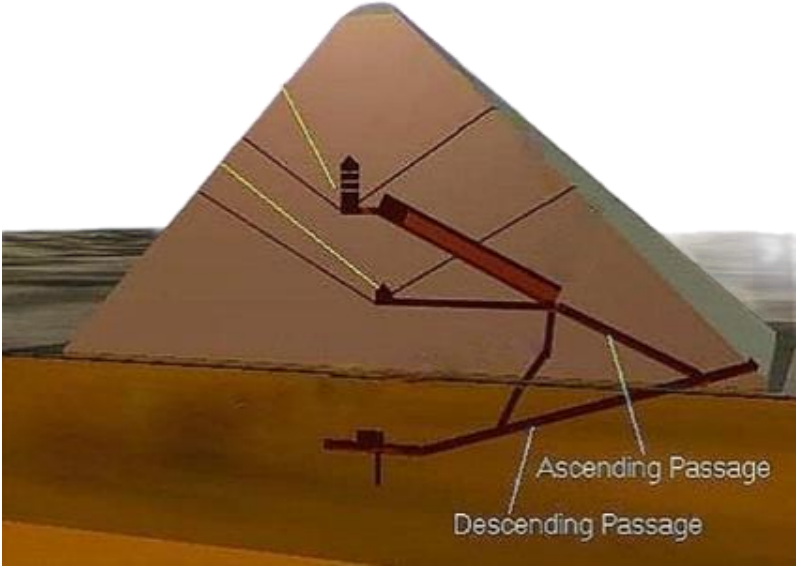

Figure 5

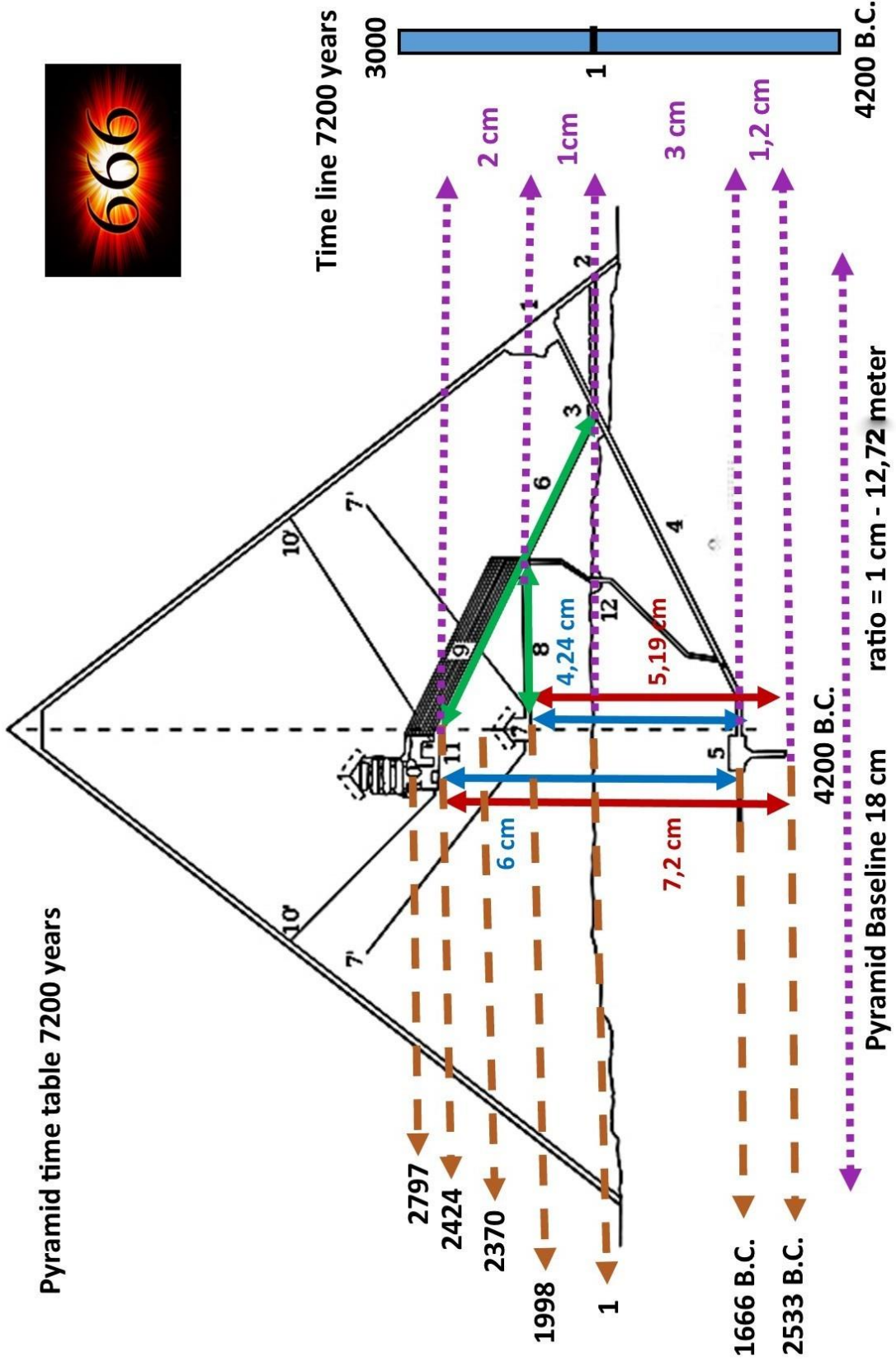
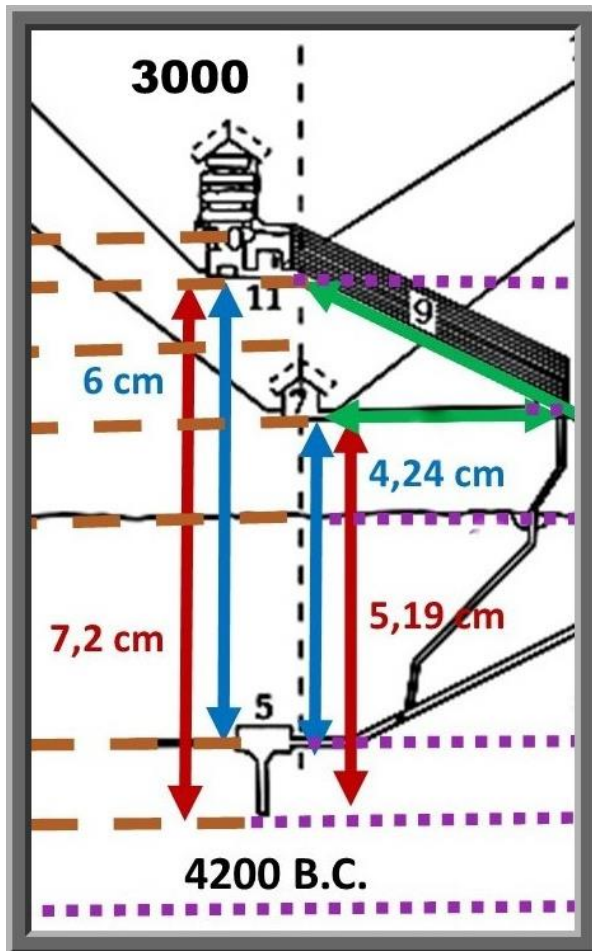

Figure 6

Figure 6 shows a detailed model of how the time calculation is constructed. At the ratio with a baseline of 18 cm (666), you get the following dimensions (measurements) between courses, figure 7.



The distance between the bottom of the king's chamber and the lowest point is 7.2 cm (red line).

The distance between the bottom of the king's chamber and the lower corridor is 6 cm (blue line).

The distance between the bottom of the queen chamber and the lowest point is 5.19 cm (red line).

The distance between the bottom of the queen chamber and the lower corridor is 4.24 cm (blue line).

Figure 7

The time reckon has a length in this case of 7.2 cm, which stands for 7,200 years. Beginning in the year 4200 B.C. and ending in the year 3000.

This corresponds to the ratio 1000 : 1 (division factor 1000).

Now it is also sometimes said that humanity must take 7 steps, seven rungs on the ladder, seven phases of time, to get where it eventually needs to be. This is more of an esoteric view.

But now let's see if we can transform Charles Taze Russell's pseudoscience (see figure 3) into science.

Are there **seven timesteps** in the Great Pyramid and if so, how do you calculate them and how do you know that this is true?

This I am going to explain to you based on "three relations" that add up to the same thing "approximately" with a deviation of about 20 - 50 years on the timeline of 7,200 years. This is because of rounding in the measures that are different on three levels, but clearly show the relationship, the connection between the three.

Figure 8 clearly shows the **7-calculation** based on the 4 measures in the Great Pyramid. Above the foundation 0 (1) the rising triangular number 666 applies and below the foundation the descending square number 6666 applies in the calculations.

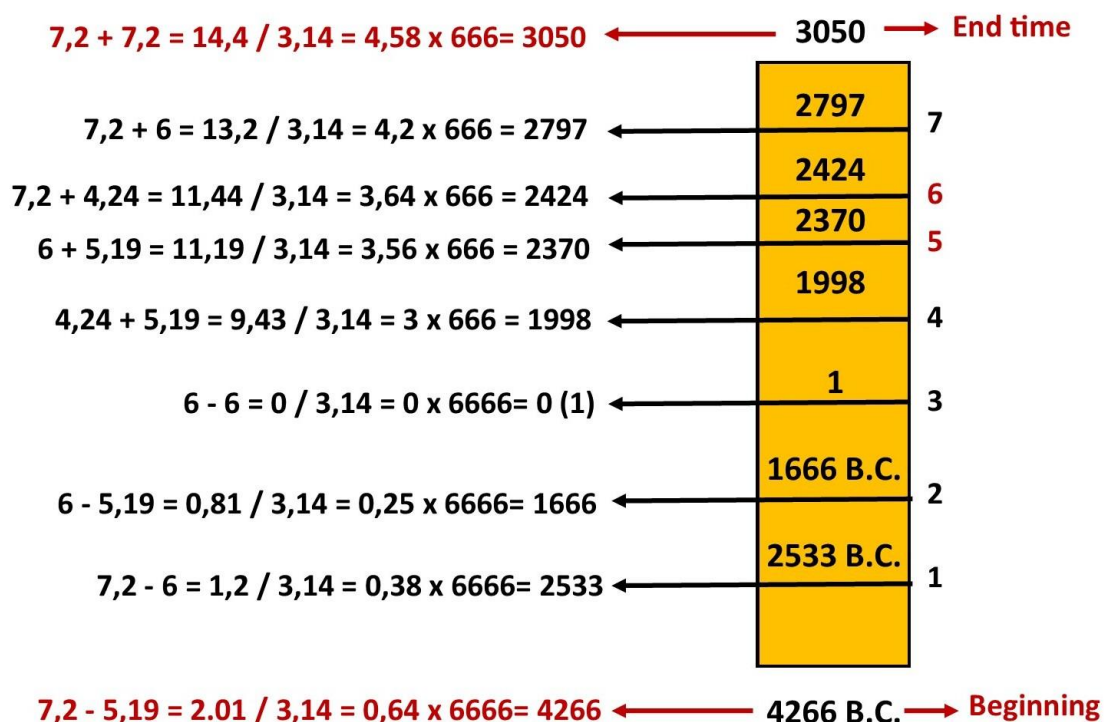

Figure 8

Charles Taze Russell was convinced until his death that the measurements in the Great Pyramid of Giza had prophetic significance. So, he couldn't prove it.

You now see how to calculate the seven phases of time in the Great Pyramid. And if, as Russel argued, the measurements in Great Pyramid have prophetic significance, then visible prophetic activity should have occurred and will occur in the computed (time phases) years shown in Figure 8.

I will come back to that in the next chapter.

**We are now going to move to another continent and make a comparison.**

From Egypt I go to Central America. In Guatemala, the Pyramid of the Jaguar is located on the Tikal (Mayan) plateau. I still have the idea that this Pyramid is mathematically (geometrically) greatly underestimated.

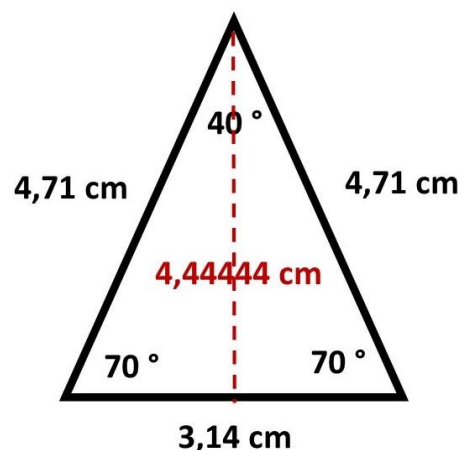

It is based on the 40° triangle. What is known about it now? See the booklets '*mathematics of the Golden Pyramid*' and '*mathematics of the Great Pyramid*'.

If you divide  $40^\circ$  by 9, you get a height of 4.4444444 ... cm. If you divide this again by  $\sqrt{2}$ , you get the number Pi = 3.1426 ... If you multiply the number Pi again by  $\sqrt{9}$ , you get two slanted sides of 9.428 ... cm is rounded 9.43 cm = 4.714 cm per side rounded.

If you are now going to calculate the Pyramid timeline of the Pyramid of the Jaguar, you must round the decimals to equals. In this case, we use four sizes: **9.43 cm, 4.71 cm, 4.44 cm, 3.14 cm.**

9.43 cm as a circumference circle. 4.71 cm as the hypotenuse. 3.14 cm as base side. **And 3 cm as a division factor** of  $9.42 / 3.14 = 3$  (rounded from  $9.43 / 3.1426 \dots$  )

Figure 9 shows the calculations. The years (time phases) are very similar to the Great Pyramid in Egypt.

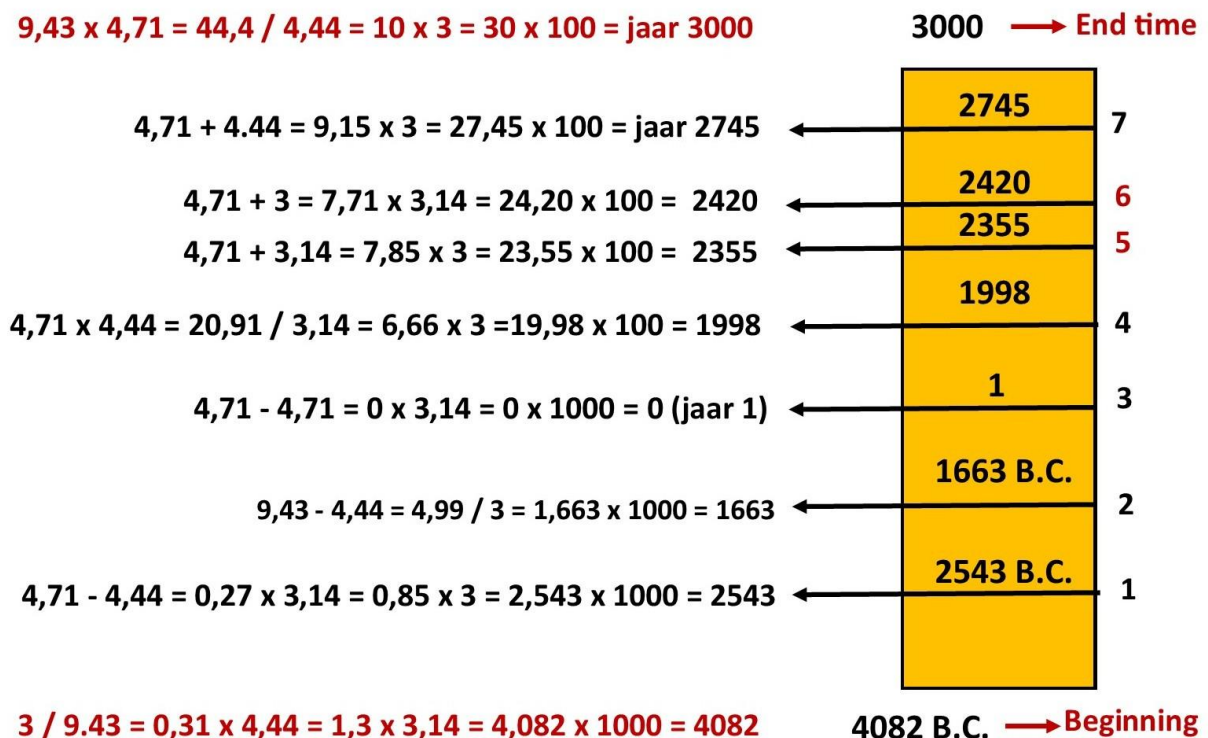

Figure 9



There are two things to note. The Mayas used a timeline of 7000 years. Second, you should know that in the Great Pyramid of Giza the 40° triangle is also present. It is located in the shafts of the queen's chamber. So, you can say that the reckoning of time is present 2 times in the Great Pyramid of Giza, calculated in two different ways. The link with the Pyramid of the Jaguar in Guatemala Tikal remains a secret for the time being. In 2020 I started researching the Pyramid of the Jaguar. I recorded the initial research in the booklet *'fundamental mathematics of the Pyramid of the Jaguar Tikal'*. Without further investigation of this Pyramid, the mathematical meaning of the 40° triangle would never have been known.

## Chapter 2

### **Lost math science in the Bible and the planet (Earth) number Pi 3.14496**

In this chapter I am going to reveal the lost mathematical knowledge stored in the Bible. I'm going to use two stories for this, the story of Noah (Genesis) and the story of the Revelation of John. Two stories no one understands.

I hope to be able to assume that the reader of this booklet is a thoughtful person and is not at a development level of 2 and 3 (childish imagery and belief in this imagery). A sea level will not rise 5 km and there is no ship (ark) that sails over (at the height of) mountain tops of 5 km high.

How can the story of Noah (who lived around the year 2533 B.C.) be explained?

He was commanded to build an "ark" 300 cubits long, 50 cubits wide, and 30 cubits high, on three stories.

Now you must know what a cubit is, in the dimensions intended at the time? There is a lot of speculation about it, but no one knows for sure. I'm going to show you exactly how much a cubit is.

What is a cubit based on? A cubit already indicates that it is connected to the elbow. One determines the distance of a cubit to the elbow and the other determines the cubit to the elbow plus hand.

However, this is not good. The cubit is the size of the ulna (see figure 10) and is set at 24 cm.



**Figure 10**

Just measure it yourself and see where you end up (approximately).

The Bible is full of stories of "hell and damnation." This creates a culture of fear among the population that takes the Bible literally (development levels 2 and 3) in a time when superstition was the order of the day, 2000 to 4000 years ago.

Whether the Bible writers 200 years after Christ probably intended it that way, in order to be able to exert power and oppression (authority) on the followers (citizens) at that time, does not seem strange. However, a modern thinking person in 2023 refers these stories to the realm of fables. Fortunately, the mathematical aspects have been preserved, even though the later Bible writers did not know of their existence.

### **What was Noah supposed to build?**

An "ark" 300 cubits long. This is converted to  $300 \times 24 = 7,200$  cm.

The width of the "ark" was to be 50 cubits. This is converted into  $50 \times 24 = 1200$  cm = 12 meters.

Its height was to be 30 cubits. This is converted to  $30 \times 24 = 720$  cm = 7.2 meters.

Noah had to build a timeline that had a length of 7,200 years. He was going to do this in a projection within a height of 7.2 meters. This means that 7,200 years had to be projected onto 7.2 meters. ( $7,200 / 7.2 = 1000$ ).

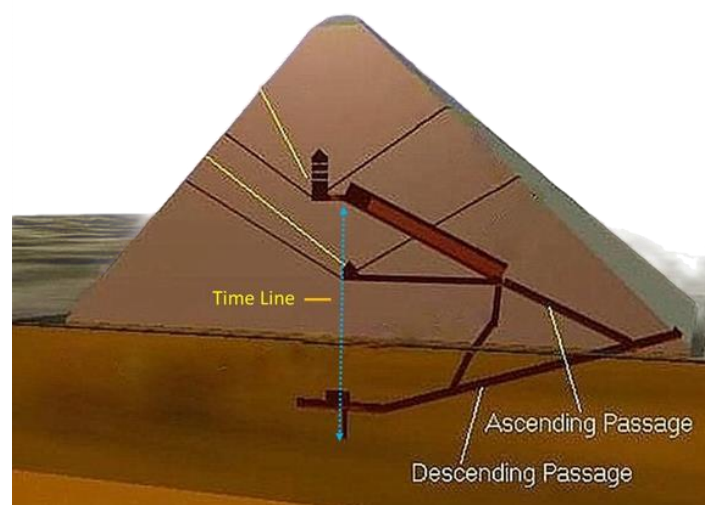

He would divide the 'ark' into 3 floors.

We are now going to look at the basis of this time reckoning. And we are now going to see how the planet number Pi arises.

We are now going to multiply the 30 cubits (7.2) by the 50 cubits (12).

This is  $7.2 \times 12 = 86.4$ . We multiply this again in the ratio 1000 of the timeline.  $86.4 \times 1000 = 86,400$ .

You will now ask yourself what am I supposed to do with this? What is this number 86,400? If I tell you now that these are the seconds of a day, of a day. An hour has 3600 seconds. A day has 24 hours.  $24 \times 3600 = 86,400$  seconds

Now a sidestep. I have explained to you in my booklets *'the golden pentagram'* and *'mathematics of the Great Pyramid'* that the number Pi is present in the pentagram. This is 3,144.

What the pentagram (of 12 cm) also shows is the number of seconds in a day.  $12 \times 7.2 = 86.4 \times 1000 = 86400$  seconds.

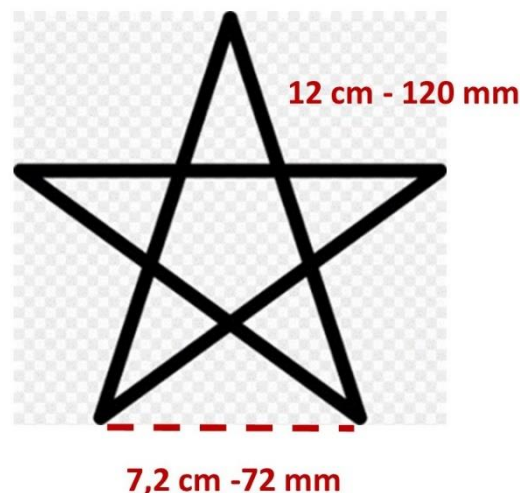

Now you need to know something else. Have you ever wondered how many days there are in a year? We assume in 2023 that there are 365. So, this is not correct.

Actually, it's simple. We assume that there are 52 weeks of 7 days.  $52 \times 7 = \mathbf{364 \text{ days}}$ . This is right.

If you read the Book of Enoch, which is a translation of the Dead Sea Scrolls, you will see exactly how the solar year is calculated in his astronomical writings. Enoch indicates that a year has **364 days**.

***Where is the evidence now?***

***So, we know that a day has 86,400 seconds. If we multiply this by 364, you get:  $364 \times 86,400 = 31,449,600$  seconds. Simplifying this to 1, you get  $31,449,600 / 10,000,000 = 3.14496$  ( $3.14496 / 1 = 3.14496$ ) So this is the planet number of the Earth;  $\pi = 3.14496$ .***

If you would calculate this with 365 days, you would see a different number: 3.1536. And that's not a Pi number.

**We are going to build (design) the 'ark' pyramid.**

If we are going to divide a cubit in a square base, then we get  $6+6+6+6 = 24$  cm. This is where the number 6666 comes from. So, this is the foundation. If we are going to determine the corresponding equilateral triangles, then the dimensions are  $6+6+6 = 18$  cm. That's where the number 666 comes from.

Noah speaks about the number 40. This has a mathematical meaning on the one hand and on the other hand this number indicates in story form: 'as long as it lasts'.

The number 40 is at the base of the base of the pyramid. So, the base line is a single line that you must multiply by 4 to get a square foundation.

### **The number 40.**

$40 / 3.143 = 12.72 \dots \times 18 (6+6+6) = 229.1$  meters. So, the pyramid is 229.1 meters square.

### **Noah speaks of the number 150.**

$150 + 12.72 = 162.72$  meters. The height of the pyramid is then 162.7 meters.

If you are going to round all this up in current modern mathematics, you will get a square base of  $4 \times 230$  meters. The height of the pyramid is then  $115 \times \sqrt{2} = 162.63$  meters. So, you see how Noah got through the calculations and recorded them.

### **Noah indicates the following in Genesis 6:5 - 9:7.**

- *In Noah six hundredth year of life, in the second month on the seventeenth day.*
- *Fifteen cubits above.*
- *The seventh month on the seventeenth day.*
- *The tenth month on the tenth month on the first of the month.*
- *In the six hundred and first year, on the first month in the first month.*
- *In the second month on the twenty-seventh day of the month.*

These are mathematical concepts and counts, even if you don't understand them now. I'm going to explain this.

Noah built a timeline with a prophetic purpose. You can only know this objective if you know how to open '*the symbolic scroll*', otherwise you will never know.

First, I'm going to put everything in the right order. Noah speaks of the number seven, seven days. These seven days again represent the 7 time periods that have been recorded in the timeline of 7200 years and that had and will have great significance in humanity.

- *In Noah six hundredth year of life, in the second month on the seventeenth day.*

$$(2 + 17 = 19 \quad 7.2 / 19 = 0.378 \times 6666 = 2526 \text{ B.C.})$$

- *In the second month on the twenty-seventh day of the month.*

$$(2 + 27 = 29 \quad 7.2 / 29 = 0.248 \times 6666 = 1655 \text{ B.C.})$$

- *In the six hundred and first year, on the first month in the first month.*

$$(1 - 1 = 0 \quad (1))$$

- *The seventh month on the seventeenth day.*

$$(7 + 17 = 24 \quad 7.2 / 24 = 0.3 \times 6666 = 1999.8)$$

- *The tenth month on the tenth month on the first of the month.*

$$(10 + 10 = 20 \quad 7.2 / 20 = 0.36 \times 6666 = 2399.7)$$

- *Fifteen cubits above.*

$$(15 \text{ cubits higher} = 15 \times 24 = 360 / 10 = 36 + 2399.7 = 2435.7)$$

- *In the six hundred and first year, in the first month in the first basket.*

$$(1 + 1 + 1 = 3 \quad 3 / 7.2 = 0.416 \times 6666 = 2773)$$

Figure 11 shows Noah's timeline.

Noah timeline 7200 years

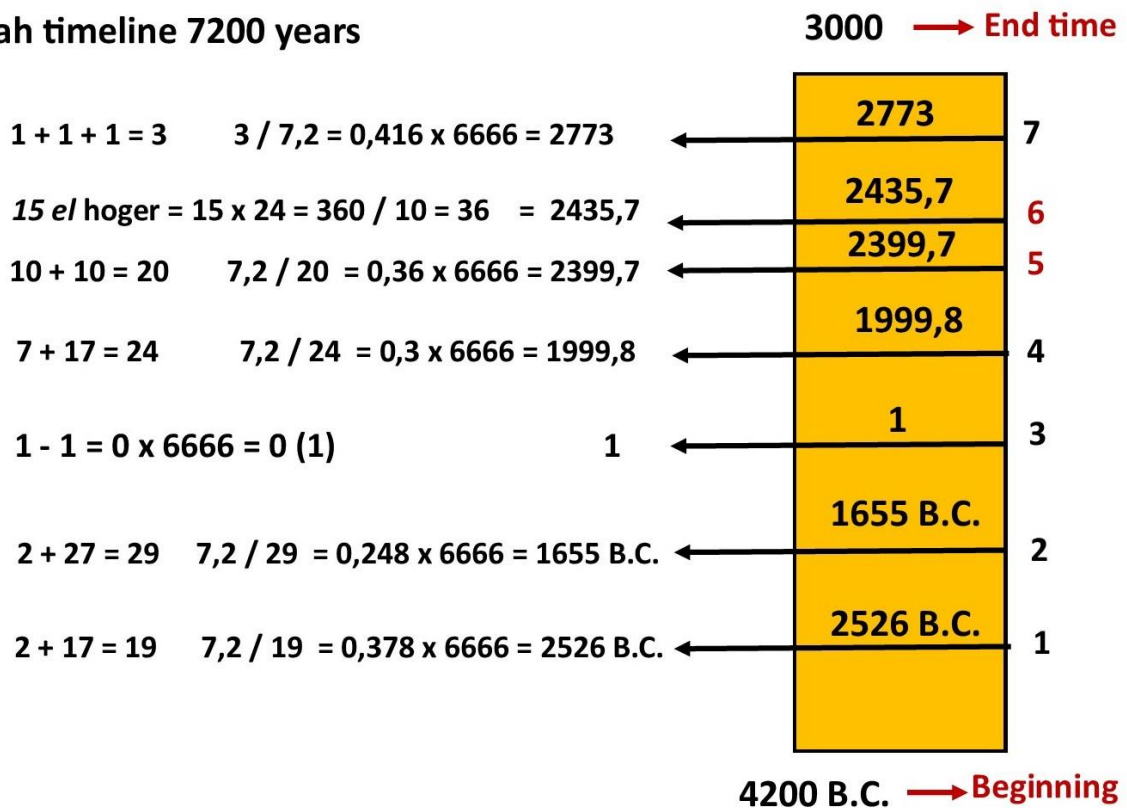
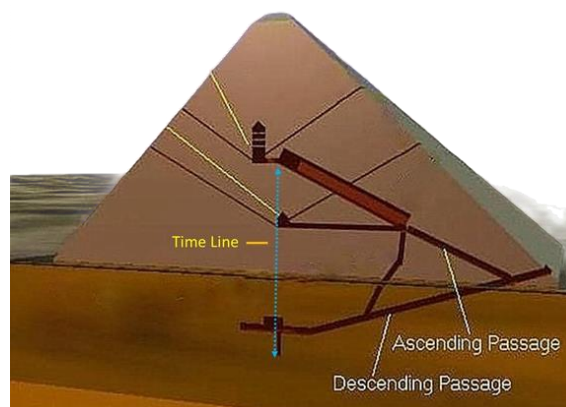

Figure 11

Very remarkable is the time now in 2023, the phase of the year 1999.8 (August 1999). I'll come back to this. Noah's timeline is perfectly aligned with the other two.



You may ask, who built the Great Pyramid, or had it built?



## The Revelation.

The Revelation of John is the last chapter in the Bible. Nobody understands what it says. Unless you've been given the knowledge.

I explain this Revelation using the seven trumpets that can be traced back to the Pyramid timeline. I'm just explaining what's important here.

**It begins with the twenty-four elders. So, this is the number 6666 ( $6+6+6+6 = 24$ ), the square foundation.**

**Then there are the four animals = 4.**

**It continues with the number 666 ( $6+6+6$ ), the equilateral triangle.**

The **seven trumpets** (annunciations) are the seven major events of significance within the **7,200-year timeline**.

***The 7 trumpets of the Revelation of John refer to the Great Pyramid and the timeline ('ark') of Noah. It is now important to begin to reveal these trumpets in the Great Pyramid. They have been imprisoned there for more than 6,000 years without anyone knowing what it means. The numbers 666 and 6666 are the two factors of calculation in the time prophecy.***



**The 7 pyramid times and the 7 trumpets.**

## Pyramid timeline Noah.

1st pyramid time and 1st trumpet.



Calculation 1st pyramid time.

$$2 + 17 = 19$$

$$7,2 / 19 = 0,378 \times 6666 \\ = 2526 \text{ B.C.}$$

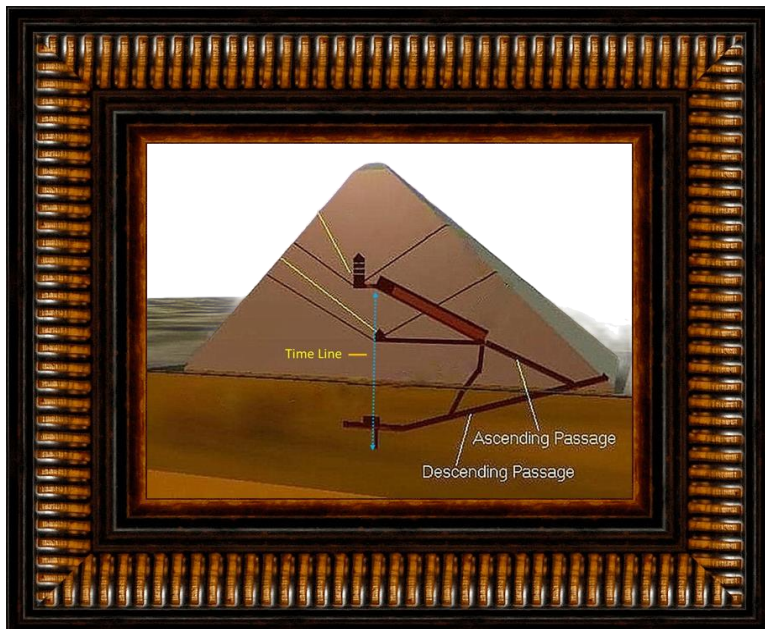

2526 BC

The time of Noah and Khufu (Cheops).

The timeline is created, and God closes and covenants with Noah.

**The 1st Trumpet.**

*And I looked, and behold a white horse, and he that sat upon it had a bow, and a crown was given unto him (according to Revelation John).*

*My bow I set in the clouds that it may be a sign of the covenant between Me and the Earth.*

*The first horseman.*

## 2nd pyramid time and 2nd trumpet.



**Calculation 2nd  
pyramid time.**

$$2 + 27 = 29$$

$$7,2 / 29 = 0,248 \times 6666 \\ = 1655 \text{ B.C}$$



**1655 B.C.**

**The time of  
Moses**

**Mount Sinai  
burns.**

**The 2nd  
Trumpet.**

## 2nd Trumpet.

*And something like a great mountain (Mount Sinai), burning with fire, was thrown into the sea, and the third part of the sea became blood, and the third part of the creatures in the sea that had life died, (dead sea) and the third of the ships perished.*

*A small meteor falls to Earth.*

*The second horseman.*

### 3rd Pyramid Time and 3rd Trumpet.



#### 3rd pyramid time.

The pyramid base is 1.  
Everything below the base  
is B.C. (BC) and everything  
above the base is A.C. (AD).



1

The time of Jesus.  
The star (meteor) of  
Bethlehem.  
The 3rd Trumpet.

### 3rd Trumpet.

*A great star (meteor), burning like a torch, fell from heaven and it fell on the third of the rivers and on the springs of waters. And the name of the star is called Wormwood (bitter). And the third part of the water became wormwood, and many of the people died from the water, because it had become bitter.*

*Jesus: Who is the faithful witness, the Firstborn from the dead.*

*The third horseman.*

## 4th pyramid time and 4th trumpet.



**Calculation 4th  
pyramid time.**

$$7 + 17 = 24$$

$$7,2 / 24 = 0,3 \times 6666 = 1999,8$$



**1999.8**

**Modern times.**

**The solar eclipse of  
1999, month (8)  
August.**

**The 4th Trumpet.**

## 4th Trumpet.

*And the third part of the sun was struck, and the third part of the moon, and the third part of the stars, so that the third part thereof was darkened, and the day had no light for the third part, and the night likewise, (eclipse of the sun). And I saw and heard an eagle flying (???) in the midst of heaven, saying with a loud voice, Woe, woe, woe to them. Who dwell on the earth, because of the other voices of the trumpets, which shall yet sound, (according to Revelation John).*

*And I saw a **new heaven** and a **new earth**, for the first heaven and the first earth had passed away... And I heard a loud voice from the throne saying: Behold, the tabernacle of God is with men, and He will dwell with them. And they shall be his peoples, and God himself shall be with them, and he shall wipe away every tear from their eyes, and death shall be no more, neither shall mourning nor lamentation nor distress be any more, for the first things are passed by. And He that sat on the throne said, Behold, I make all things new. And He said. Write, for these words are faithful and true. I will be his God and he shall be my son. But the cowardly, the disbelievers, the abominable, the murderers, the whoremongers, the sorcerers, the idolaters, and all liars, their portion is in the pool. Who burns with fire and brimstone: **this is the second death.***

### **The two witnesses**

*And after that, and half a day, the Spirit of life from God entered into them, and they stood upon their feet, and great fear fell upon all them that beheld them. And they heard a loud voice from heaven saying to them: Come up hither. And they ascended to heaven 'in a cloud' (???), and their enemies beheld them.... And **“the cloud”** took them to **“a new heaven”** and a new earth.*



**"New heaven, realm of the dead"**



**New earth**

## 5th pyramid time and 5th trumpet.



**Calculation 5th  
pyramid time.**

$$10 + 10 = 20$$

$$7,2 / 20 = 0,36 \times 6666 \\ = 2399,7$$



**2399.7**

**The future time.  
History repeats  
itself. An  
unexpected and  
unseen comet  
destroys the Earth.  
The 5th Trumpet.**

## 5th Trumpet.

*And I saw a star (comet) fallen from heaven to the earth (Abaddon), and the key to the pit of the abyss was given to her. And she opened the pit of the abyss, and smoke ascended out of the pit, like the smoke of a great furnace, and the sun and the sky were darkened by the smoke of the pit. And from the smoke locusts (fall - out - dust) came out on the earth and power was given to them, as the scorpions on earth have power.*

*And it was told them that they should not harm the grass of the earth, nor any herb, nor any tree, but only those men who had not the seal of God on their foreheads.*

*And it was given to them that they should not kill them, but that men should be tormented five months; and their torment was as the torment of a scorpion, when it stings a man. And in those days men will seek death, but will not find it, and they will long to die, but death will flee from them.*

### **Five months and the number 5.**



**Meaning in this context: Until the sky is clear....**

*The hee is the fifth letter of the alphabet with numerical value five.*

***The meaning is 'window', 'look out', 'see'. The original form of the letter was the image of a praying or calling man with arms raised.***

*The image of the letter is a house with an opening in the left wall, a window that offers the possibility to look outside. The hee is therefore associated with looking out of the house for the existence of this world, keeping one's gaze fixed on the world.*

***The first woe is past: behold, two more woes come after this.***

***Around the same time 36 years later, the 6th trumpet will sound, and the final phase of the timeline will be ushered in.***



## 6th Pyramid Time and 6th Trumpet.



Calculation 6th pyramid time.

15 cubits higher =

$$15 \times 24 = 360 / 10 = 36 + 2399.7 = 2435.7$$

## 6th Trumpet.

*And I heard a voice from the four horns (overpressure "floodgates") of the golden altar (inner hot mass of the earth).*



**2435.7**

**The future time.**

**Four fires (super volcanoes) will erupt and spread their ashes over the earth.**

**The 6th Trumpet.**

*And the four angels (**four super volcanoes**) who had been prepared against the hour, and the day, and the month, and the year were released. And the number of the armies (**fall-out**) of the cavalry was twice ten thousand ten thousand; I heard their number.*

## 7th pyramid time and 7th trumpet.



Calculation 7th  
pyramid time.

$$1 + 1 + 1 = 3$$

$$3 / 7.2 = 0.416 \times 6666 = \\ 2773$$



**2773**

And the temple of  
God which is in  
heaven was opened,  
and the ark of his  
covenant appeared  
in his temple....

He will destroy those  
who destroy the  
Earth.

## 7th Trumpet.

*The kingdom of the world has come to our Lord and to his Anointed One, and He will reign as king for ever and ever.*

*According to the Revelation of John.*

## Is it true or false?

The calculation is clearly and geometrically captured in the cross-section of the Pyramid timeline.

John, presumably without knowing it himself, is rendering an ignorant prophecy, which is (approximately) equal to Noah's Pyramid timeline, at this time in 2023.

### The sealed scroll and the Lamb.

#### 5:1-14

*And I beheld, and I heard the voice of many angels round about the throne, and of the beasts, and of the elders: and the number of them was ten thousand ten thousand, and thousands of thousands.*

*According to the revelation of John.*

#### What does that mean?

$10,000 \times 10,000 = 100,000,000.$

$1000 \times 1000 = 1,000,000$

$100,000,000 / 1,000,000 = 100$

So, there are 24 elders and 4 animals.

If we now multiply 100 by 24, we get the year **2400**. The time in which the **fifth and sixth trumpet** will take place.

If we now subtract 4 from 24, we get 20. 20 times 100 is the year **2000**. The time of the **fourth trumpet**.

If we now add 4 to 24, we get 28. 28 times 100 is the year **2800**. The time of the **seventh trumpet**.

**You can't say that all four timelines were created just for fun. This has been carefully and professionally thought through mathematically.**

Charles Taze Russell was convinced until his death that the measurements in the Great Pyramid of Giza had prophetic significance. See his figure 3.

So, it is now confirmed.

Now the question: do I believe this?

For that I go back to the year 1998.



4th trumpet: Great Pyramid:  $4.24 + 5.19 = 9.43 / 3.14 = 3 \times 666 = \text{year } 1998$

4th trumpet: Pyramid Tikal:  $4.71 \times 4.44 = 20.91 / 3.14 = 6.66 \times 3 = 19.98 \times 100 = \text{year } 1998.$

4th trumpet Noah: The seventh month on the seventeenth day:  $7 + 17 = 24 \quad 7.2 / 24 = 0.3 \times 6666 = \text{year } 1999.8.$

Who exactly predicted it to the month? Noah, more than 4500 years ago. He predicted the solar eclipse in 1999 to the nearest month 8. Because on August 11, 1999, was the great solar eclipse. **The fourth trumpet.**

## **What exactly happens in these time phases?**

It is therefore not the case that immediately spectacular changes can be observed at the trumpet. It can sometimes take several years to decades before the sighting is recognized, it starts earlier and ends later. The first four trumpets (the four horsemen) are only assigned the number 666 (given). And the work was outsourced over 30 years ( $1260 / 42 = 30$  years long according to John's revelation). The period of the fourth trumpet will then end in the **year 2052**.

The **fifth trumpet** is the worst thing that can happen to mankind, but it is inevitable. It is a comet cycle that has been studied for centuries. It will streak past Earth in part and much of it will obscure it in the sunlight.

He comes like a thief says John revelation, unseen and unannounced. He comes from behind the sun and the human being on Earth cannot perceive that. He cannot see behind the sun. So, Noah says **the year 2399.7 (2399 in the seventh month)**.

**After that, the Earth is again unlimitedly safe.**

The sixth trumpet is not bad.

The future will tell.

In 2023 we no longer know as humans whether the Bible is true. Or that Noah, Moses, and Jesus were just fictional characters. We are no longer involved in it in the Western world. This is because religious institutions do not keep up with the times. And they have themselves to blame for that. Consciousness develops to level 10 and religion adheres to (dwells at) levels 2 and 3.

While modern people walk in "spacesuits", religious leaders walk in kaftans and miters. I give advice, wake up and enter the world of development. Then you can balance religion with what it is supposed to be. Now you lose everything that the "previous horsemen" built with difficulty and with the loss of their own lives.

*... And men did not repent of the works of their hands ....., says John in his Revelation.*

Man is quickly forgotten and quickly returns to the order of the day.

And that will continue in 2023, until he is shaken awake in **the year 2399 (in the seventh month)**.

## **Chapter 3**

### **Some (mathematical) numbers in the Revelation, the birth of Mohammed and the announcement of the Muslim world.**

#### **The New Jerusalem. 21:9-22:5**

The Revelation of John is a book of prophecy, written as a repetition of the story of Noah (2,500 years later) to remind man once more that the prophecy of 7,200 years continues and that the seven days (seven times) to the end time in the year 3000.

The New Jerusalem is not a fictional story of a "fantastic world" somewhere in the afterlife. But a realistic view of the time then and how it developed in the coming centuries.

The Revelation is a book about the prophecy that started with Noah and ends in the year 3000. It is a warning that you underestimate as a human being and can sometimes become very painful.

It is about how the old familiar Jerusalem underwent a renewal and took on a new meaning for the '**144,000 initiates**'.

John writes:

*And he carried me away in the spirit and into a great and high mountain and showed me the holy city of Jerusalem.*

*And it had a great high wall, and it had 12 gates, and on the gates 12 angels.*

*To the east were three gates, and to the north three gates, and to the south three gates, and to the west three gates.*

*And the wall of the city had 12 foundations.*

*And he that talked with me had a golden measuring rod to measure the city, and the gates thereof, and the wall thereof. And the city lay in a square, and its length was as great as its breadth; and he measured the city with his rod, twelve thousand furlongs; its length and its breadth and its height were equal.*

*And he measured its wall, one hundred and forty-four cubits. Human size, which is angel size.*

**What was it that John saw in his vision?**

**I'm going to build you this city now.**

We start with the twelve gates of twelve.

3 east, 3 north, 3 south, 3 west.

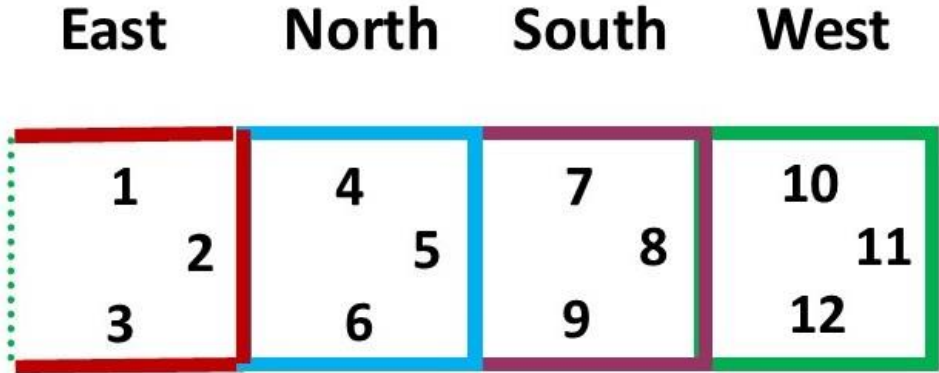

**12 gate's - 12 sides**

If you connect these ports together, port 10:11:12 with 1:2:3, you get a perfect cube.

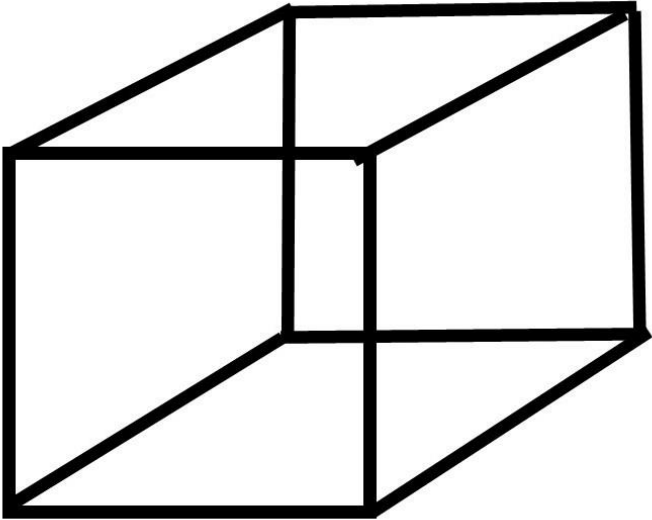

12 gates represent the 12 sides of the cube. Each side has a length of 12,000 x 12,000 = 144,000 mm is 144 meters. So we build a cube of 144 meters per side.



We are now going to make the cube into a sacred symbol to perfection, like the pyramid.

We see that if you build the cube on the ground, you can observe 5 visible square faces. So, you don't see the base (foundation).

We are now going to determine the time reckoning of the cube.

We divide 144,000 by 5 (five squares) and then by 4 (square).

$$12,000 \times 12,000 = 144,000 / 5 = 28,800 / 4 = 7,200 \times 12 = 86,400$$

And here you see again that the cube represents 1 day (86,400 seconds).

If you were to walk around it, you could symbolically say that you have traveled a day.

If you multiply this by 364 days (1 year), you get 31,449,600 seconds.

This is the perfect Pi planet Earth number  $31,449,600 / 10,000,000 = 3.14496$ .

A symbolic circle around the 144-meter square cube means you have traveled 1 year.

If you simplify the cube by 10, you get a cube with a ratio of 14.4 meters per side.

*Two numbers are mentioned in the Bible, ten thousand thousandths (10,000 – 1000). These numbers are used in several variations. 1st Variation =  $10,000 \times 10,000 / 1000 \times 1000 = 100$ . 2nd =  $2 \times \text{Ten Thousand Thousandths} = 2 \times 100 = 200$ . 3rd Variation  $10,000 / 1000 = 10$ . And they stand for what they are in a division and multiplication factor.*

And what is the most important thing in the prophecy of the cube?

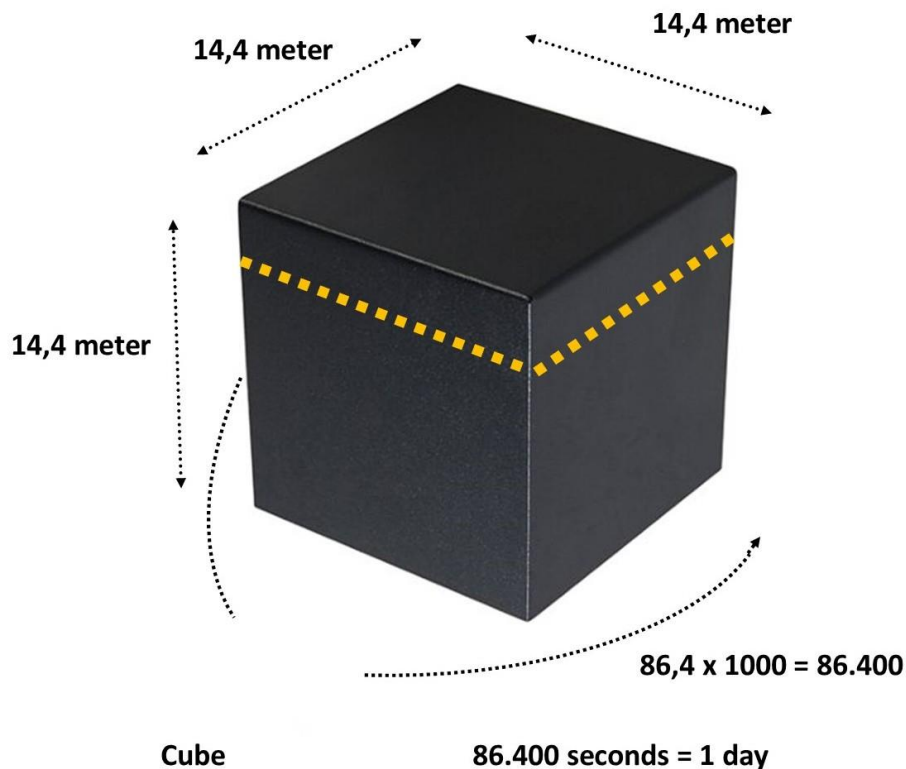

He announces **the birth of Prophet Muhammad.  $144 \times 4 = \text{year } 576$ .** The year of birth of Prophet Mohammed. ( $14.4 \times 4 \times 10$ ). The timeline is also clearly displayed in the cube.  $144 \times 5 = 720 \times 10 = \mathbf{7,200 \text{ years}}$ . ( $14.4 \times 5 \times 100$ ). In this case you can say it is a golden 'sacred' cube.

### **The lamb and the ransomed 14:1-5**

**144,000.**

*..... and they sang a new song before the throne and before the four beasts and the elders; and none could learn their song but the 144,000, the ransomed from the earth. These are they who have not defiled themselves with women, for they are virgins. These are they who follow the Lamb wherever He goes. These are bought from among men as firstfruits to God and the Lamb. And in their mouth no lie was found; they are blameless.*

## **Jerusalem and the New Jerusalem.**

For Christians, it is the city where Jesus was crucified. For Muslims, it is the place where the Prophet Muhammad prayed along with the souls of all the prophets and also his point of departure to heaven. For Jews, Jerusalem is the place where the Second Temple stood, of which only the so-called Wailing Wall remains.

The Temple Mount is where the two Jerusalem's meet. The old traditional Jerusalem and the new Jerusalem. The Temple Mount is the connection.

You can now say that there is no sign of connection. Both 'Jerusalem's' are not driven by God's Spirit but by the battle of the Lamb. So, they are equal to each other, in the connection of the Lamb 'the struggle of life' and that for about 1500 years now.

But in the year 2399 in the 7th month, according to the prophecy, the whole world will be shaken awake. Armageddon.

We will see.

### **Two Witnesses 11:1-14**

The two witnesses have 2 meanings. On the one hand, it is connected to the 4th trumpet and the 2 worlds one of which has come.

On the other hand, it announces the other two (5th and 6th) trumpets.

*And I will charge my two witnesses (5th and 6th trumpet)... To prophesy for 1260 days. And after three and a half days (3.5) the Spirit of life from God entered into them... A tenth of the city... (10)*

**1260 / 3.5 = 360 / 10 = 36 years. (36 years after the fifth trumpet).**

## **The woman and the dragon 12:1-6**

*And a great sign was seen in heaven: a woman (Earth) clothed with the sun, with the moon under her feet (solar eclipse), and a crown of 12 stars on her head.*

*... another sign seen in heaven: ... a great red dragon (fourth horseman, fourth trumpet) , with 7 heads and 10 horns and on his heads 7 crowns ( $7 + 7 + 10 = 24$ ).*

***$7.2 / 24 = 0.3 \times 6666 = 1999.8$ . The year 1999 in the 8th month.***

*And his tail dragged a third of the stars of heaven and threw them to the earth.  $12 / 3 = 4$  (4th Horseman - 4th Trumpet)*

*1260 days = as it says in the prophecy.*

## **The dragon persecutes the woman 12:13-18**

***2 wings of the great eagle (5th and 6th trumpet)***

*A time and times and half a time.  $1 + (1+1) 2 + 0.5 = 3.5$ .*

***$1260 / 3.5 = 360 / 10 = 36$  years. (36 years after the fifth trumpet)***

*The 6th trumpet follows the 5th trumpet 36 years later.*

## **The Harvest 14:14-20**

***1600 stages  $16 + 00 = 16$***

***$7.2 / 16 = 0.45 \times 6666 = 2999.7$  (3000)***

***The end time.***

## **The Judgment of Babylon 17:1-18**

*And I saw a woman sitting on a scarlet colored beast.... and it had 7 heads and 7 horns*

*I will tell you the mystery of the woman and of the beast with 7 heads and 10 horns.*

*Makes  $7 + 17 = 24$ .*

*The 7 heads and 7 mountains on which the woman is seated = (14)*

*Also they are 7 kings. 5 fallen and 1 is still there = (13) and the other has not come yet*

*And the beast ... is itself also the 8th .... but it is out of the 7 = (15)*

*Makes  $13 + 14 + 15 = 42$ .*

*The number 42 is the number of prophecy.*

*$1260 / 42 = 30$  years of prophets (3rd and 4th horsemen).*

*The 1st prophecy is:*

*7 heads and 17 horns = 24.*

***$7.2 / 24 = 0.3 \times 6666 = 1999.8$ . The year 1999 in the month of August.***

*The 2nd prophecy is:*

*And the 10 horns which you saw are 10 kings = (20)*

***$7.2 / 20 = 0.36 \times 6666 = 2399.76$ . The year 2399 in month 7 (July).***

## Closing word.

This booklet has been written with the aim of making people aware of the four timelines contained in the Pyramids and the Bible (Noah and the Revelation of John). Four timelines that hardly deviate from each other in the seven-time phases.

They are two timelines geometrically hidden in the Pyramids and cryptically hidden in the Bible awaiting its revelation.

The end time is approaching.

... yet they did not repent of the works of their hands.... writes John.

We will see.

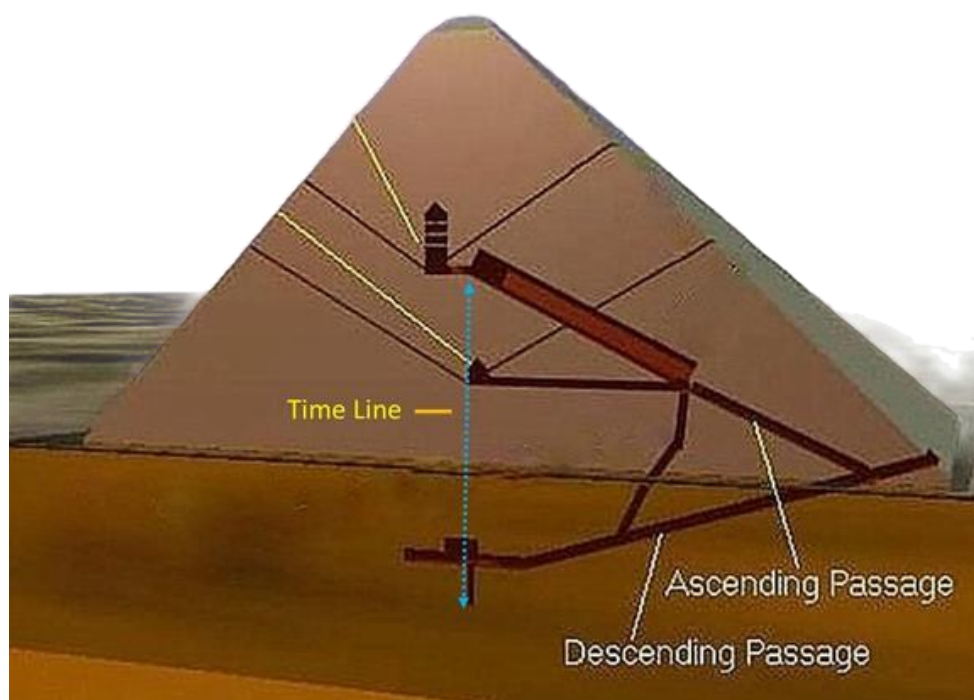

Wim van Es

January 2023.

*God does not die out when we  
cease to believe in God, but we  
cease to live when we are no  
longer enlightened by that  
daily, wondrous experience of  
the Source of Life, which  
surpasses all understanding.*

Dag Hammarskjöld

ISBN: 978-90-9036990-7